



RGB-M-1250-DB, Electronic Modular Gas Burner (Dual block configuration)

Specifications

- Electronic modulating burner with capacity of 1200-1250 kW on gas side (120-1250 Nm³/h for G20), and turn down ratio of 1:10, and NOx class II.
 - Compatible with all types of combustion chambers according to EN-303 or BS-EN 12953 standards.
 - Suitable for fire tube, fire box, water tube boilers, etc.
 - The burner includes: mechanical components, burner head, flame tube, control panel, ignition devices, air pressure switches, Ignition transformers, valves and all necessary safety devices in the gaseous fuel lines.
 - Burner controller: AUTOFLAME MINI MK8/MK8 or SIEMENS LMV5 depends on the policy of the manufacturer based on the market availability or the customer's order.
 - The controller includes: main controller (PID controller), user interface, flame detector, actuators.
 - Burner ventilation system with 13800 m³/h capacity and 65 millibar supply pressure.
 - The BVS includes: Fan motor, mechanical components, FGR (optional) and sound proofing material for further reduction in sound level (optional).
 - The RMS includes: Inverter, fan, Emergency switch, Compact switch MCCB (optional) and electrical components for power system.
 - The gas train includes: filter, regulator, main and safety valve, pressure gauges, maximum pressure switch, minimum and leak test pressure switch, pilot regulator, pilot valves, butterfly valve, (All according to BS-EN 676).
- The recommended gas trains are offered in two types:
- DN100 Multi-block low-pressure gas train (inlet pressure of 260-360 mbar).
 - DN100 Separate high-pressure gas train (inlet pressure of 1-4 bar).
- Advantages: optimal design, high modulating ratio, valve proving system, communication with external systems via Bus, ease of installation and maintenance.
 - Optional ability: running with FGR (Flue Gas Recirculation) in order to further reduction in NOx level, variable speed drive, running with O₂ and CO sensors (plus CO₂, NO, NO₂, and SO₂ sensors with AUTOFLAME controller), LPG fuel compatibility with LPG nozzle kits.



More information

- BVS motor: 30 kW, 3 Phase, 380-400 Volt, 50 Hz, 2900 rpm
 - Operating ambient temperature: 5-60°C
 - Maximum combustion air temperature: 60°C
 - Casing insulation class: IP43
 - Combustion block weight: 460 kg ±1%
 - Combustion block Packing dimensions (L x W x H): ~2020 x 1050 x 1150 mm
- Reference conditions: Ambient temperature 20°C - Gas temperature 15°C - Barometric pressure 1013 mbar - Altitude 0 m (According to BS-EN 676)

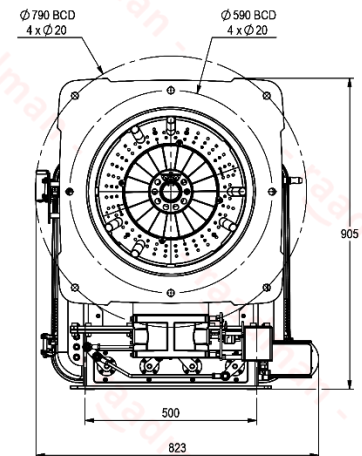
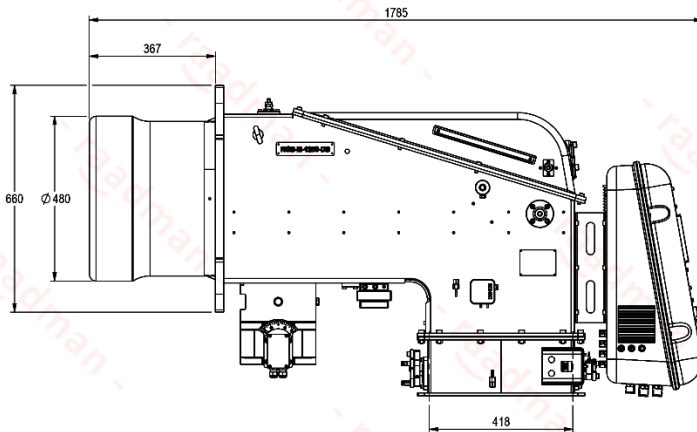
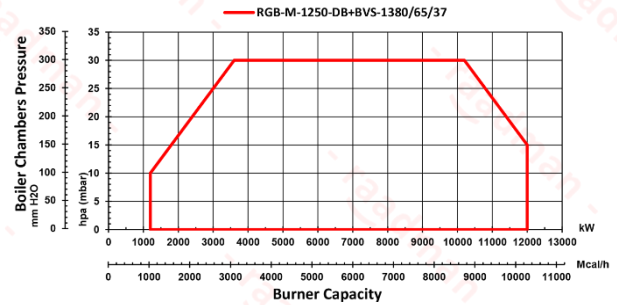

- Suggested boiler flange diameter = 492 mm

Certifications

- Certified in EAEU countries standard No. 0378484.
- Certified in Iran national standard ISIRI-7595 (BS-EN 676).



Scan to access:
 Technical proposal
 Technical data
 Technical consultation
 Cad model (only for VIP customers)

