



RGB-MC-505/LN, Low NOx Mechanical Modular Gas Burner

Specifications

- Mechanical modulating burner with capacity of 700-5100 kW on gas side (70-510 Nm³/h for G20), and turn down ratio of 1:7, and NOx class III.
- Compatible with all types of combustion chambers according to EN-303 or BS-EN 12953 standards.
- Suitable for fire tube, fire box, water tube boilers, etc.
- The burner includes: mechanical components, low NOx burner head designed for emission reduction, flame cover, air fan, control panel, ignition devices, valves and all necessary safety devices in the gaseous fuel line.
- Burner controller: SIEMENS LFL
The controller includes: main controller (PID controller), load control module, actuators.
- The gas train includes: filter, regulator, main and safety valve, pressure gauges, maximum pressure switch, minimum pressure switch, and leak test pressure switch, valve proving system (All according to BS-EN 676).
The recommended gas trains are offered in two types:
 - DN65 multi-block low-pressure gas train (inlet pressure of 228-360 mbar).
 - DN65 separate high-pressure gas train (Inlet pressure of 1-4 bar).
- Advantages: optimal design, high modulating ratio, silent operation, the ability to open from the hinge to both sides and ease of installation and maintenance.
- Optional ability: LPG fuel compatibility with LPG nozzle kits.



More information

- Fan motor: 11 kW, 3 Phase, 380-400 Volt, 50 Hz, 2900 rpm.
- Operating ambient temperature: 5-60°C
- Maximum combustion air temperature: 60°C
- Noise emission level: 88 dB in 1.5-meter distance
- Casing insulation class: IP43
- Net weight: ~222 kg
- Packing dimensions (L x W x H): ~1850 x 1140 x 890 mm

Reference conditions: Ambient temperature 20°C - Gas temperature 15°C
- Barometric pressure 1013 mbar - Altitude 0 m (According to BS-EN 676)

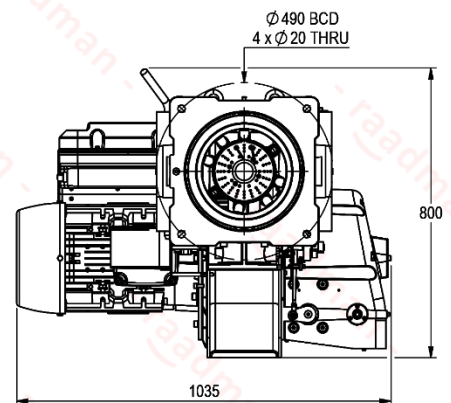
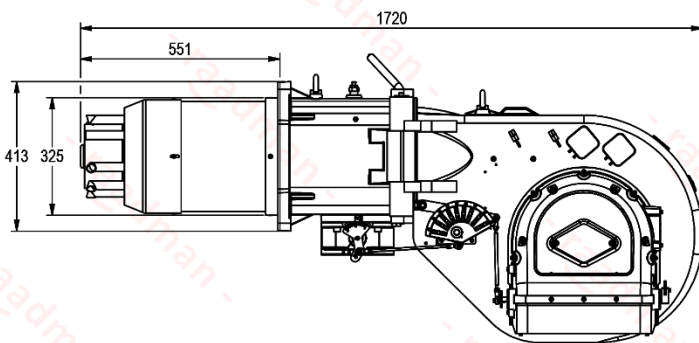
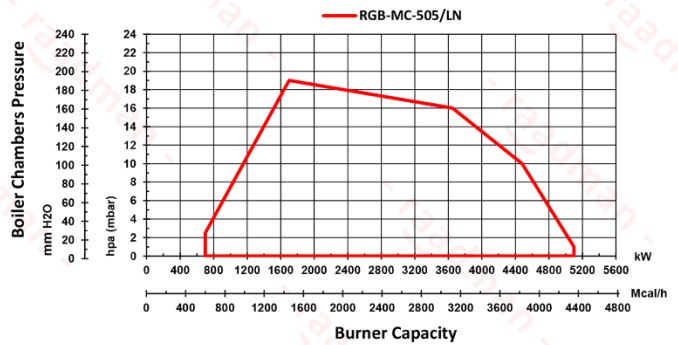

- Suggested boiler flange diameter = 337 mm

Certifications

- Certified in EAEU countries standard No. 0378484.
- Certified in Iran national standard ISIRI-7595 (BS-EN 676).



Scan to access:
Technical proposal
Technical data
Technical consultation
Cad model (only for VIP customers)

