

RLGB-MC-385/LN, Low NOx Mechanical Modulating Dual Fuel Burner

Specifications

- Mechanical modulating burner with capacity of 650-3500 kW on gas side (65-350 Nm³/h for G20), and turn down ratio of 1:5, and NOx class III.
- Two stage burner with capacity of 650-3500 kW on light oil side (55-295 kg/h), and turn down ratio of 1:5, and NOx class II.
- Compatible with all types of combustion chambers according to EN-303 or BS-EN 12953 standards.
- Suitable for fire tube, fire box, water tube boilers, etc.
- The burner includes: mechanical components, low NOx burner head designed for emission reduction, flame tube, air fan, light oil delivery system, control panel, ignition devices, valves and all necessary safety devices in the gaseous and light oil fuel lines.
- Burner controller: SIEMENS LFL
The controller includes: main controller (PID controller), load control module, flame detector, actuators.
- The gas train includes: filter, regulator, main and safety valve, pressure gauges, maximum pressure switch, minimum and leak test pressure switch, valve proving system (All according to BS-EN 676).
The recommended gas trains are offered in two types:
 - DN65 separate low-pressure gas train (Inlet pressure of 90-360 mbar).
 - DN65 separate high-pressure gas train (Inlet pressure of 1-4 bar).
 - If higher pressures are available, lower gas train sizes can be offered for better prices.
- Light oil delivery system includes: separate motor for oil pump, pump with pressure regulating valve, double main solenoid valve and one safety solenoid valve in feeding line, pressure gauge in feeding line, two nozzles for two stage operation (All according to BS-EN 267).
- Advantages: optimal design, high modulating ratio, independent oil motor and air motor, silent operation, the ability to open from the hinge to both sides and ease of installation and maintenance.
- Optional ability: LPG fuel compatibility with LPG nozzle kits.



More information

- Fan motor: 7.5 kW, 3 Phase, 380-400 Volt, 50 Hz, 2900 rpm.
- Light oil fuel pump motor: 1.5 kW, 380-400 Volt, 50 Hz, 2890 rpm
- Operating ambient temperature: 5-60°C
- Maximum combustion air temperature: 60°C
- Noise emission level: 78 dB in 1.5-meter distance
- Casing insulation class: IP43
- Net weight: ~260 kg
- Packing dimensions (L x W x H): ~1790 x 1285 x 920 mm

Reference conditions: Ambient temperature 20°C - Gas temperature 15°C
- Barometric pressure 1013 mbar - Altitude 0 m (According to BS-EN 676)

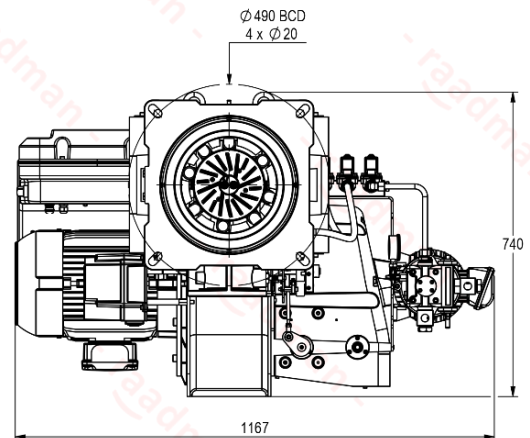
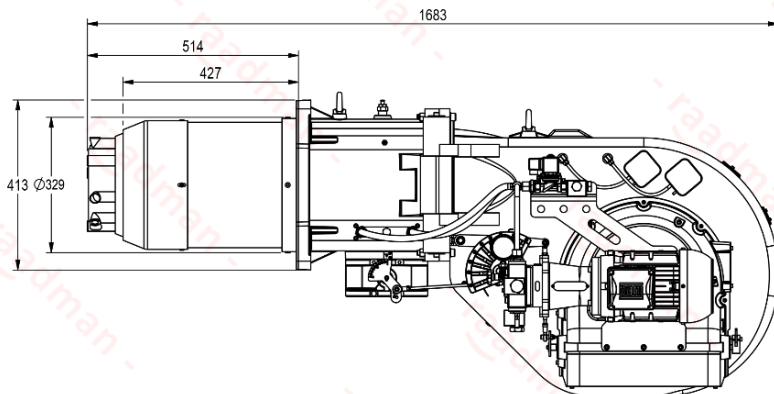
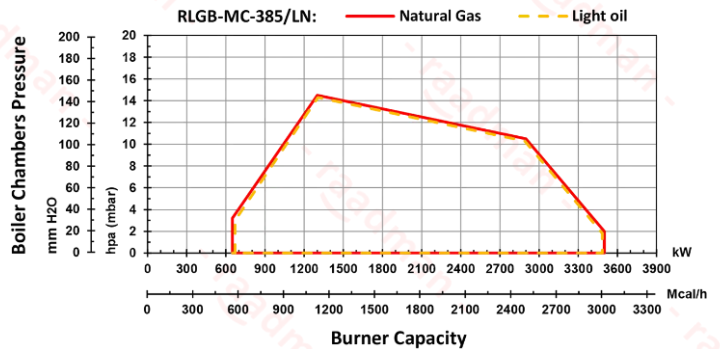

- Suggested boiler flange diameter = 335 mm

Certifications

- Certified in EAEU countries standard No.0378483.
- Certified in EAEU countries standard No. 0378484.
- Certified in Iran national standard ISIRI-7594 (BS-EN 267).
- Certified in Iran national standard ISIRI-7595 (BS-EN 676).



Scan to access:
 Technical proposal
 Technical data
 Technical consultation
 Cad model (only for VIP customers)

