



RLGB-MS-145, Mechanical Staging Dual Fuel Burner

Specifications

- Mechanical Staging burner with capacity of 400-1380 kW on gas side (40-138 Nm³/h for G20), and turn down ratio of 1:4, and NOx class II.
- Two stage burner with capacity of 400-1380 kW on light oil side (34-116 kg/h), and turn down ratio of 1:4, and NOx class II.
- Compatible with all types of combustion chambers according to EN-303 or BS-EN 12953 standards.
- Suitable for fire tube, fire box, water tube boilers, etc.
- The burner includes: mechanical components, flame tube, air fan, light oil delivery system, control panel, ignition devices, valves and all necessary safety devices in the gaseous and light oil fuel lines.
- Burner controller: SIEMENS LFL or SHOKOUH/HONEYWELL TMG depends the policy of manufacturer based on the market availability or on the customer's order.
The controller includes: main controller, flame detector, actuator.
- The gas train includes: filter, regulator, main and safety valve, pressure gauges, maximum pressure switch, minimum and leak test pressure switch, valve proving system (All according to BS-EN 676).

The recommended gas trains are offered in two types:

- Rp2 multi-block low-pressure gas train (inlet pressure of 49-360 mbar).
- Rp2 separate low-pressure gas train (inlet pressure of 49-360 bar).
- If higher pressures are available, lower gas train sizes can be offered for better prices.
- Light oil delivery system includes: separate motor for oil pump, pump with pressure regulating valve, double main solenoid valve and one safety solenoid valve in feeding line, pressure gauge in feeding line, two nozzles for two stage operation (All according to BS-EN 267).
- Advantages: optimal design, high modulating ratio, independent oil motor and air motor, silent operation, the ability to open from the hinge to both sides and ease of installation and maintenance.
- Optional ability: LPG fuel compatibility with LPG nozzle kits.



More information

- Fan motor: 2.2 kW, 3 Phase, 380-400 Volt, 50 Hz, 2890 rpm.
- Light oil fuel pump motor: 0.55 kW, 380-400 Volt, 50 Hz, 2890 rpm
- Operating ambient temperature: 5-60°C
- Maximum combustion air temperature: 60°C
- Noise emission level: 80 dB in 1.5-meter distance
- Casing insulation class: IP43
- Net weight: ~91 kg
- Packing dimensions (L x W x H): ~1225 x 780 x 745 mm

Reference conditions: Ambient temperature 20°C - Gas temperature 15°C
- Barometric pressure 1013 mbar - Altitude 0 m (According to BS-EN 676 and BS-EN 267).

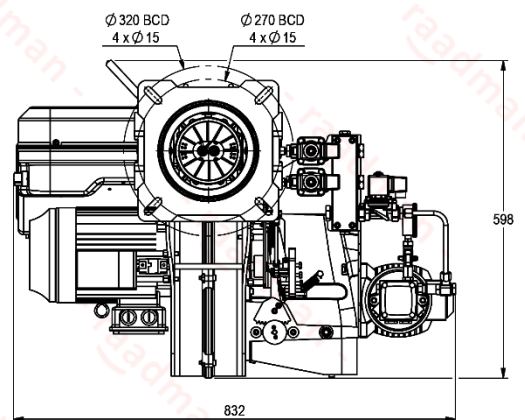
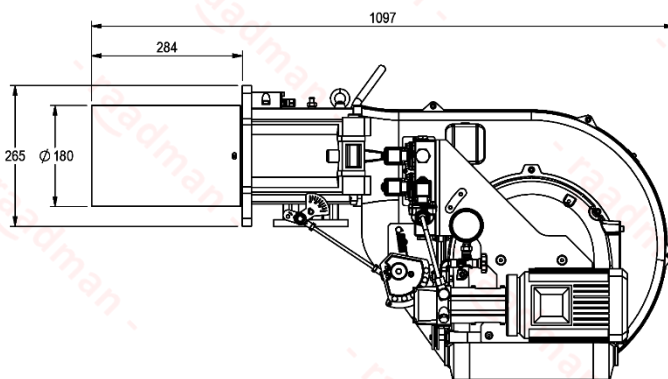
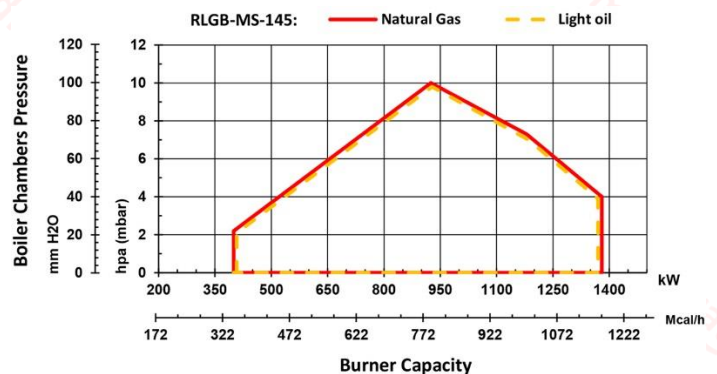

- Suggested boiler flange diameter = 202 mm

Certifications

- Certified in EAEU countries standard No.0378483.
- Certified in EAEU countries standard No. 0378484.
- Certified in Iran national standard ISIRI-7594 (BS-EN 267).
- Certified in Iran national standard ISIRI-7595 (BS-EN 676).



Scan to access:
Technical proposal
Technical data
Technical consultation
Cad model (only for VIP customers)

